



Characteristics of an On-Premises Cloud

Carmelo McCutcheon
VP of Global Presales

What is On-Prem Cloud?

On-Prem Cloud or Composable Cloud should be an all-inclusive platform that combines hardware and software that gives you the **incremental scale** the **control, and Simple Management of a Public Cloud**.

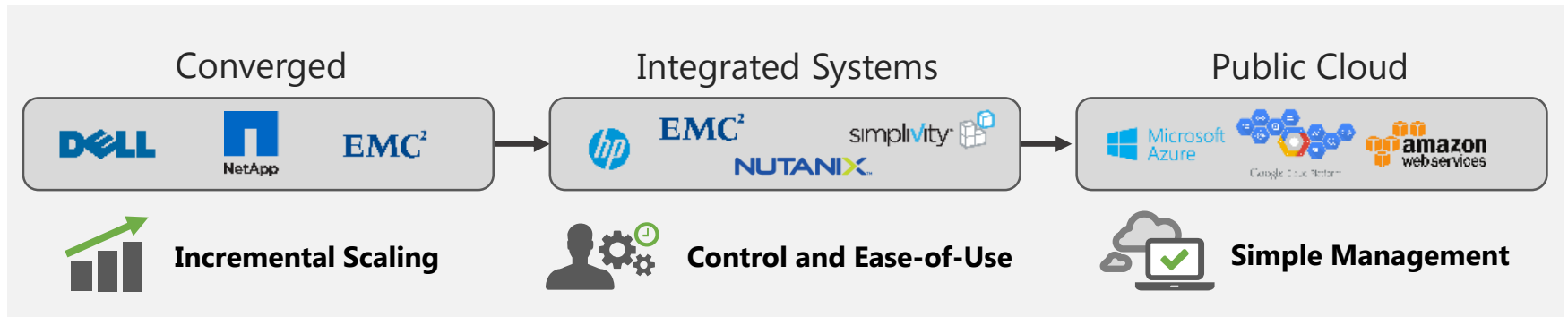

From Complex to Simple

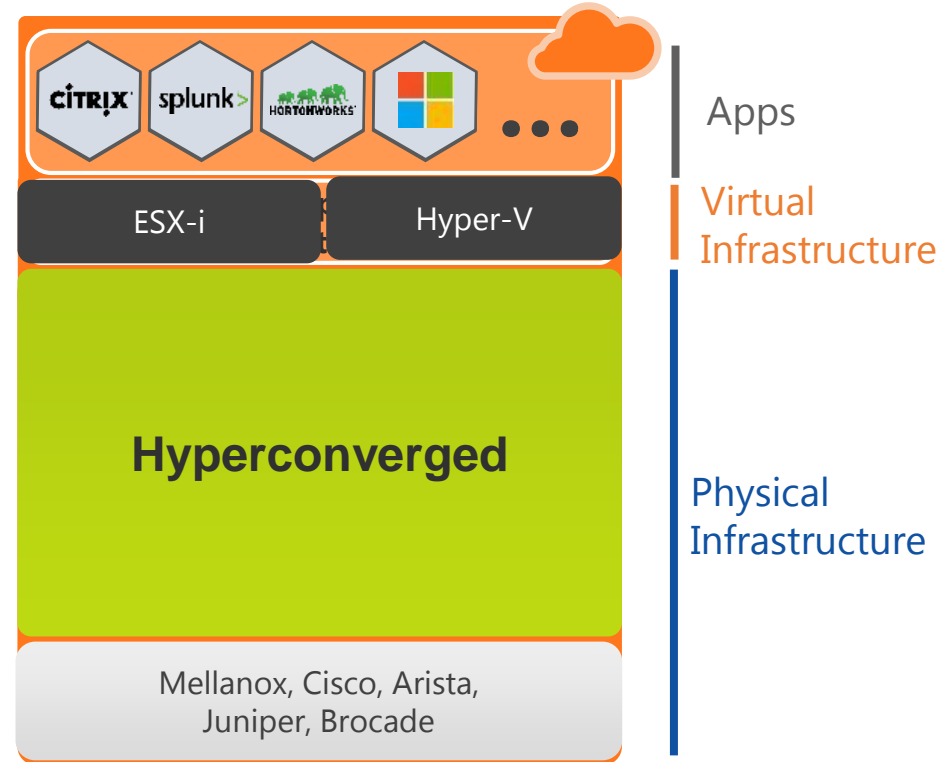
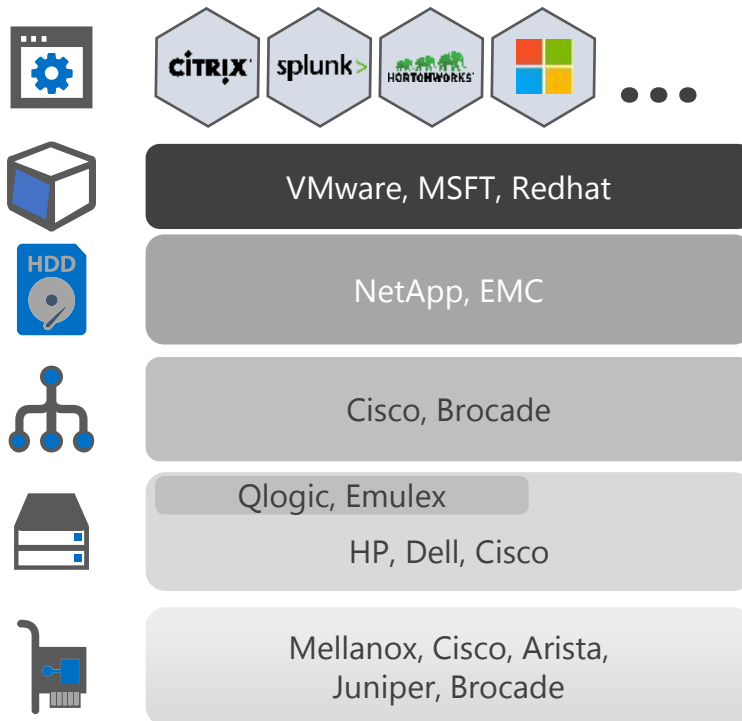

A Complete Composable Cloud Platform

The only all-inclusive cloud platform

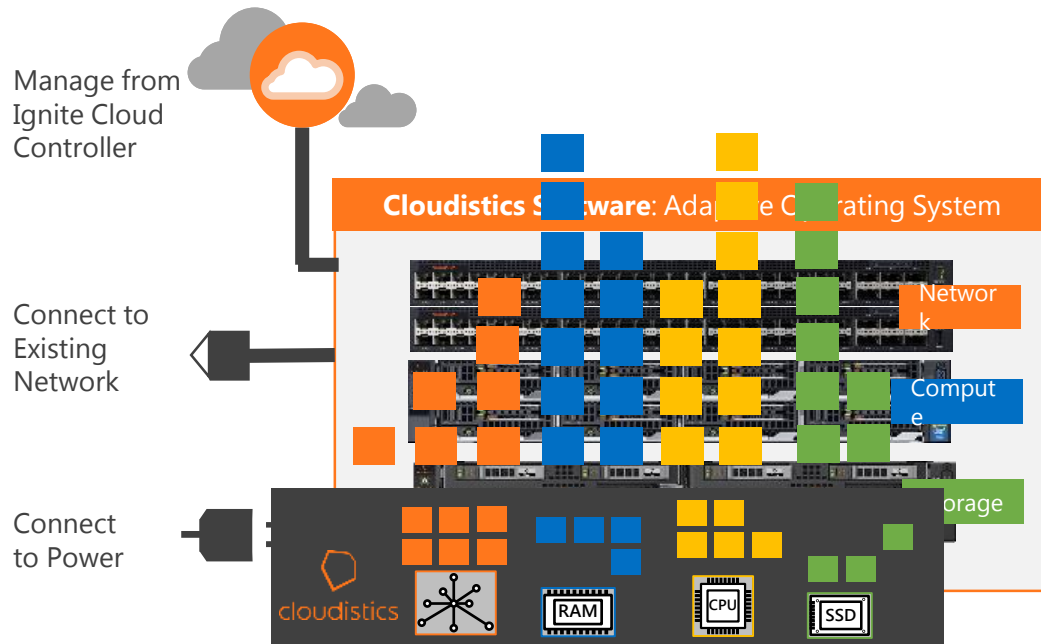

All hardware and all software including the hypervisor



Centralized management of everything from a SaaS portal



Independent scaling on-demand, without disruption



High performance applications of all workloads

A Complete Composable Cloud Platform

The only all-inclusive cloud platform

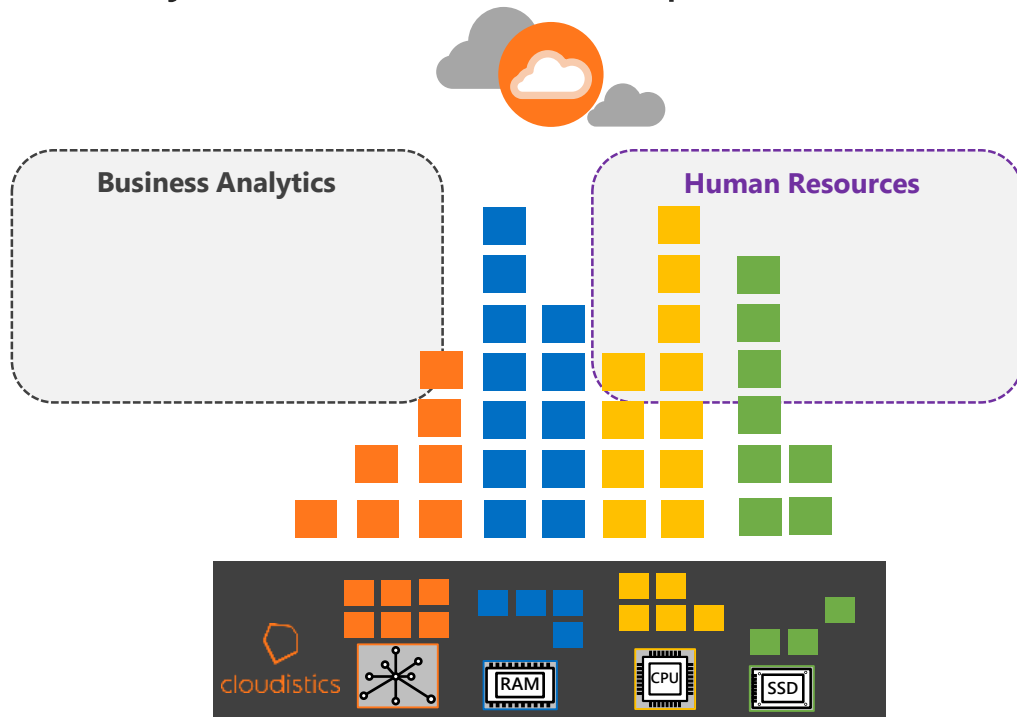

All hardware and all software including the hypervisor



Centralized management of everything from a SaaS portal



Independent scaling on-demand, without disruption



High performance applications of all workloads



Full-stack **Multi-Tenancy**

Modern Applications for an On-Prem Cloud

General Purpose Open Source



Enterprise Apps



Big Data



Containers

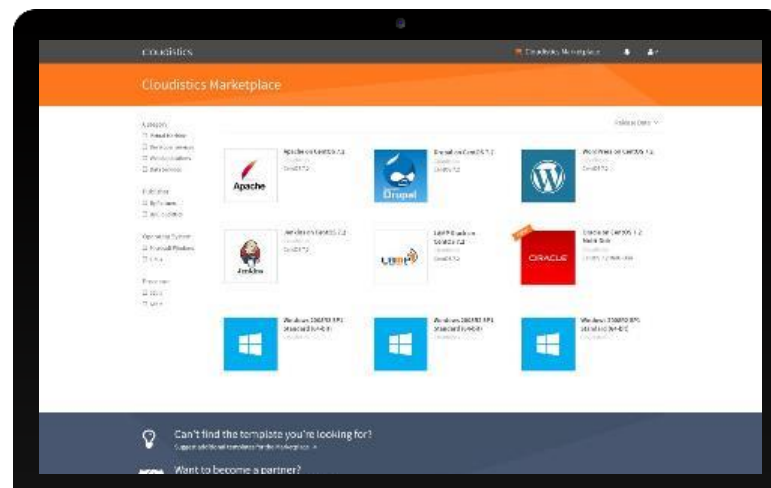

Cloud Economics

Scale Up and Out Pay-As-You-Grow

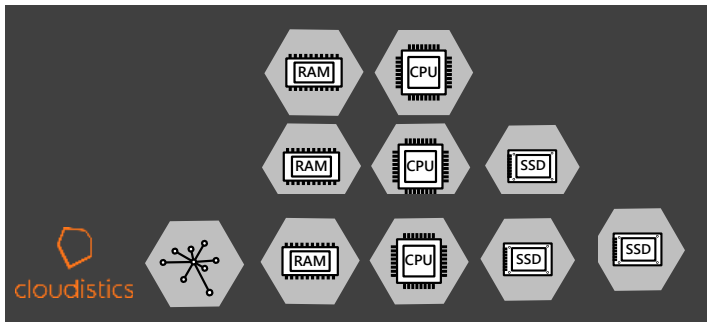

Consumption Model Cloud Experience, Lower Cost

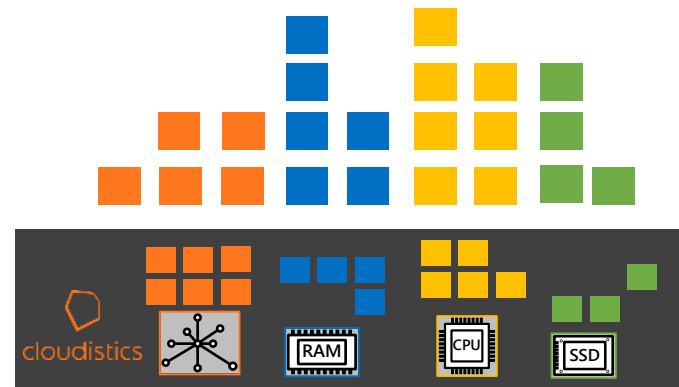

Cloudistics On-Premises Cloud Platform



Complete Cloud Platform



Simple Management



Application Specific Flexibility



Multi-Tenancy



Reliable High Performance



“Unlimited” Incremental Scale



Cloud Economics

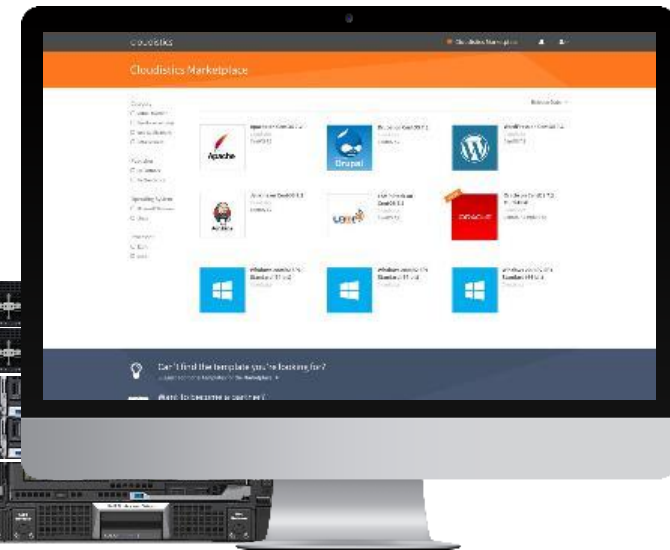

How to Get Started



Schedule a Technical Session



Low-Risk Test Drive

Visit Us: www.cloudistics.com/virtual-lab

Contact us: Sales@cloudistics.com